

Subminiature Size Ideal for PCB Mounting (12.8 × 6.5 × 5.8 (W × H × D))

- Incorporating a snapping mechanism made with two highly precise split springs that ensures a long service life.
- Insertion molded terminals and a two-stage bottom with different levels prevent flux penetration.
- Self-clinching PCB, right-angle, and solder terminals are available.
- Meets a wide range of applications, including home appliances, audio equipment, office machines, and communications equipment.



Ordering Information

■ Model Number Legend

D2F-□□□□
1 2 3 4

1. Ratings

None: General load
01: 0.1 A at 30 VDC

2. Operating Force max.

None: 1.47 N {150 gf}
F: 0.74 N {75 gf}

Note: These values are for the pin plunger model.





3. Actuator

None: Pin plunger
L: Hinge lever
L2: Hinge roller lever
L3: Simulated roller lever

4. Terminals

None: PCB terminal/straight terminal
-T: Self-clinching PCB terminal
-A: Right-angle PCB terminal
-D3: Solder terminal
-D: Compact solder terminal

■ List of Models

Actuator	Operating force (OF) (see note)	Micro voltage/current load		Standard	
		0.1 A		1 A	3 A
		Low operating force 0.74 N {75 gf}	General-purpose 1.47 N {150 gf}	Low operating force 0.74 N {75 gf}	General-purpose 1.47 N {150 gf}
Pin plunger 	PCB terminals	D2F-01F	D2F-01	D2F-F	D2F
	Self-clinching terminals	D2F-01F-T	D2F-01-T	D2F-F-T	D2F-T
	Right-angle terminals	D2F-01F-A	D2F-01-A	D2F-F-A	D2F-A
	Solder terminals	D2F-01F-D3	D2F-01-D3	D2F-F-D3	D2F-D3
	Compact solder terminals	D2F-01F-D	D2F-01-D	D2F-F-D	D2F-D
Hinge lever 	PCB terminals	D2F-01FL	D2F-01L	D2F-FL	D2F-L
	Self-clinching terminals	D2F-01FL-T	D2F-01L-T	D2F-FL-T	D2F-L-T
	Right-angle terminals	D2F-01FL-A	D2F-01L-A	D2F-FL-A	D2F-L-A
	Solder terminals	D2F-01FL-D3	D2F-01L-D3	D2F-FL-D3	D2F-L-D3
	Compact solder terminals	D2F-01FL-D	D2F-01L-D	D2F-FL-D	D2F-L-D
Simulated roller lever 	PCB terminals	D2F-01FL3	D2F-01L3	D2F-FL3	D2F-L3
	Self-clinching terminals	D2F-01FL3-T	D2F-01L3-T	D2F-FL3-T	D2F-L3-T
	Right-angle terminals	D2F-01FL3-A	D2F-01L3-A	D2F-FL3-A	D2F-L3-A
	Solder terminals	D2F-01FL3-D3	D2F-01L3-D3	D2F-FL3-D3	D2F-L3-D3
	Compact solder terminals	D2F-01FL3-D	D2F-01L3-D	D2F-FL3-D	D2F-L3-D
Hinge roller lever 	PCB terminals	D2F-01FL2	D2F-01L2	D2F-FL2	D2F-L2
	Self-clinching terminals	D2F-01FL2-T	D2F-01L2-T	D2F-FL2-T	D2F-L2-T
	Right-angle terminals	D2F-01FL2-A	D2F-01L2-A	D2F-FL2-A	D2F-L2-A
	Solder terminals	D2F-01FL2-D3	D2F-01L2-D3	D2F-FL2-D3	D2F-L2-D3
	Compact solder terminals	D2F-01FL2-D	D2F-01L2-D	D2F-FL2-D	D2F-L2-D

Note: The OF values shown in the table are for the pin plunger models.

Specifications

■ Ratings

Item	OF max.	D2F models		D2F-01 models	
		1.47 N {150 gf} (General-purpose)	0.74 N {75 gf} (Low operating)	1.47 N {150 gf} (General-purpose)	0.74 N {75 gf} (Low operating)
Resistive load					
Rated voltage	125 VAC	3 A	1 A	---	
	30 VDC	2 A	0.5 A	0.1 A	

- Note:**
- Consult your OMRON representative before using the Switch with inductive or motor loads.
 - The ratings values apply under the following test conditions:
 Ambient temperature: 20±2°C
 Ambient humidity: 65±5%
 Operating frequency: 30 operations/min

■ Characteristics

Operating speed	1 to 500 mm/s (at pin plunger models)
Operating frequency	Mechanical: 200 operations/min Electrical: 30 operations/min
Insulation resistance	100 M Ω min. (at 500 VDC)
Contact resistance (initial value)	D2F models: 30 m Ω max. D2F-F models: 50 m Ω max. D2F-01 models: 100 m Ω max.
Dielectric strength	600 VAC, 50/60 Hz for 1 min between terminals of the same polarity 1,500 VAC, 50/60 Hz for 1 min between current-carrying metal parts and ground (see note 1), and between each terminal and non-current-carrying metal part
Vibration resistance (see note 2)	Malfunction: 10 to 55 Hz, 1.5-mm double amplitude
Shock resistance (see note 2)	Destruction: 1,000 m/s ² {approx. 100G} max. Malfunction: 300 m/s ² {approx. 30G} max.
Life expectancy	Mechanical: 1,000,000 operations min. (Refer to <i>Engineering Data</i> .) Electrical: 30,000 operations min. (Refer to <i>Engineering Data</i> .)
Degree of protection	IP00
Degree of protection against electric shock	Class I
Proof tracking index (PTI)	175
Ambient temperature	Operating: -25°C to 65°C (at ambient humidity of 60% max.) (with no icing)
Ambient humidity	Operating: 85% max. (for 5°C to 35°C)
Weight	Approx. 0.5 g (pin plunger models)

- Note:**
1. The dielectric strength shown in the table indicates a value for models with a Separator.
 2. For the pin plunger models, the values are at the free position and total travel position. For the lever models, they are at the total travel position.

■ Approved Standards

UL1054 (File No. 41515)
CSA C22.2 No. 55 (LR21642)

Rated voltage	D2F (general-purpose)	D2F (low operating force)	D2F-01
125 VAC	3 A	1 A	---
30 VDC	2 A	0.5 A	0.1 A

■ Contact Specifications

Item		D2F models	D2F-01 models
Contact	Specification	Crossbar	
	Material	Silver alloy	Gold alloy
	Gap (standard value)	0.25 mm	
Minimum applicable load		100 mA at 5 VDC	1 mA at 5 VDC

■ Contact Form

SPDT

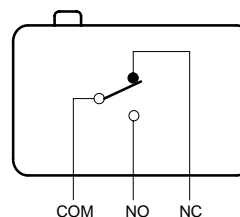

Engineering Data

Mechanical Life Expectancy (D2F, D2F-01)

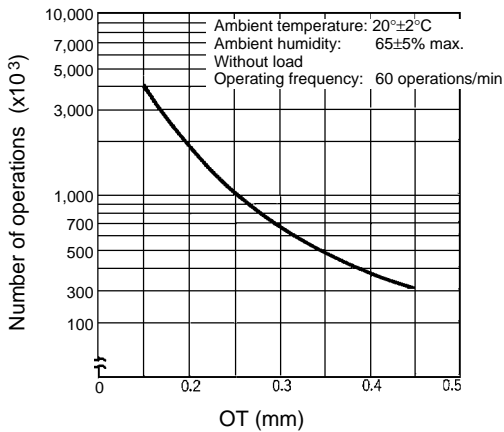

The values are for the pin plunger model.

Electrical Life Expectancy (D2F)

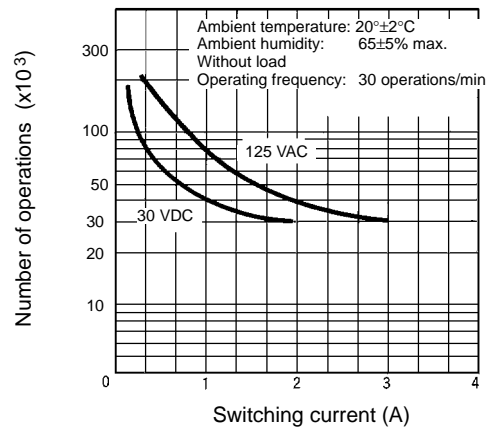

For details about the D2F-01, contact your OMRON sales representative.

Dimensions

Note: All units are in millimeters unless otherwise indicated.

Terminals

PCB Terminals (Standard)

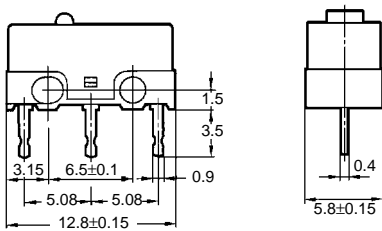

Self-clinching PCB Terminals

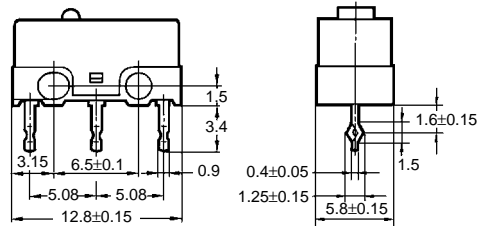

Right-angle PCB Terminals

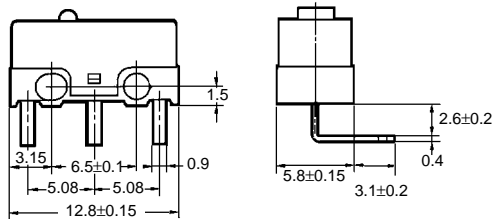

PCB Mounting Dimensions (Reference)

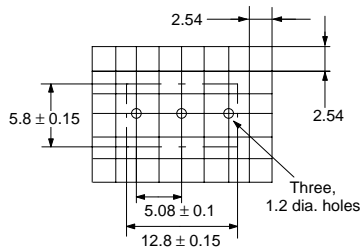

Solder Terminals

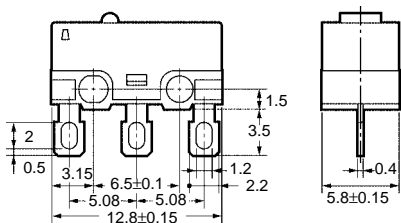

Compact Solder Terminals

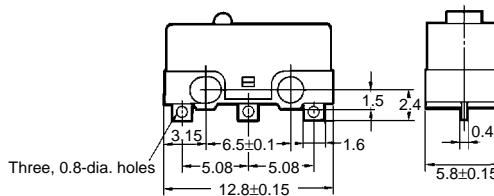

■ Mounting Holes

Two, 2-dia. mounting holes

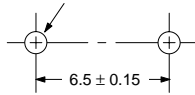

■ Dimensions and Operating Characteristics

- Note:**
1. All units are in millimeters unless otherwise indicated.
 2. Unless otherwise specified, a tolerance of ±0.4 mm applies to all dimensions.
 3. The following illustrations and drawings are for D2F models with PCB terminals. Self-clinching, solder, and right-angle terminals are omitted from the following drawings. Refer to page 180 for these terminals. When ordering, replace □ with the code for the terminal that you need.
 4. The operating characteristics are for operation in the A direction (▼).

Pin Plunger

- D2F□
- D2F-01□
- D2F-F□
- D2F-01F□

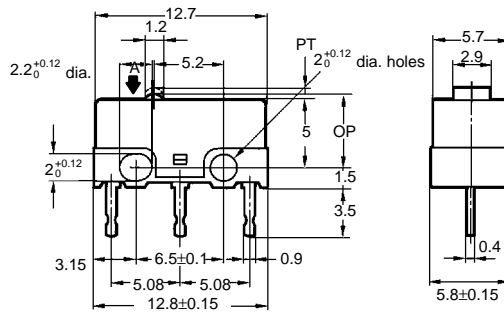
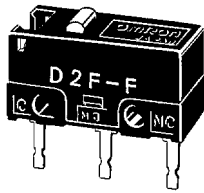

Model	D2F□ D2F-01□	D2F-F□ D2F-01F□
OF max.	1.47 N {150 gf}	0.74 N {75 gf}
RF min.	0.20 N {20 gf}	0.05 N {5 gf}
PT max.	0.5 mm	
OT min.	0.25 mm	
MD max.	0.12 mm	
OP	5.5±0.3 mm	

Hinge Lever

- D2F-L□
- D2F-01L□
- D2F-FL□
- D2F-01FL□

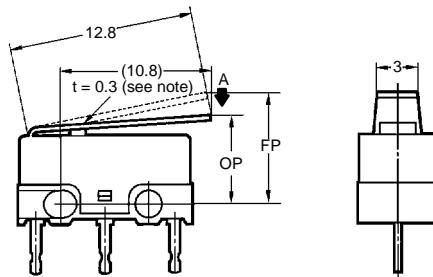
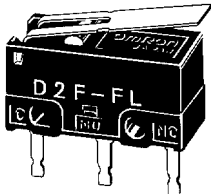

Note: Stainless-steel lever

Model	D2F-L□ D2F-01L□	D2F-FL□ D2F-01FL□
OF max.	0.78 N {80 gf}	0.25 N {25 gf}
RF min.	0.05 N {5 gf}	0.02 N {2 gf}
OT min.	0.55 mm	
MD max.	0.5 mm	
FP max.	10 mm	
OP	6.8±1.5 mm	

Simulate Roller Lever

- D2F-L3□
- D2F-01L3□
- D2F-FL3□
- D2F-01FL3□

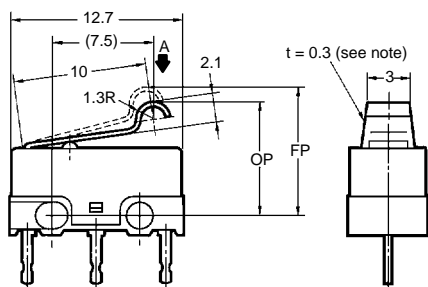
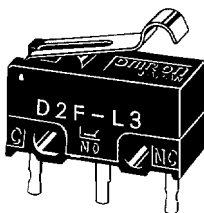

Note: Stainless-steel lever

Model	D2F-L3□ D2F-01L3□	D2F-FL3□ D2F-01FL3□
OF max.	0.78 N {80 gf}	0.39 N {40 gf}
RF min.	0.05 N {5 gf}	0.02 N {2 gf}
OT min.	0.5 mm	
MD max.	0.45 mm	
FP max.	13 mm	
OP	8.5±1.2 mm	

Hinge Roller Lever

- D2F-L2□
- D2F-01L2□
- D2F-FL2□
- D2F-01FL2□

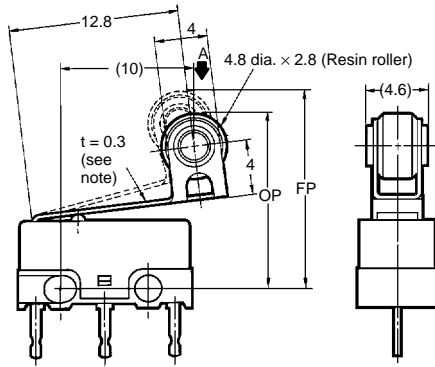
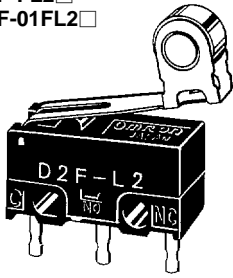

Note: Stainless-steel lever

Model	D2F-L2□ D2F-01L2□	D2F-FL2□ D2F-01FL2□
OF max.	0.78 N {80 gf}	0.39 N {40 gf}
RF min.	0.05 N {5 gf}	0.02 N {2 gf}
OT min.	0.55 mm	
MD max.	0.5 mm	
FP max.	16.5 mm	
OP	13±2 mm	

Precautions

Refer to pages 26 to 33 for common precautions.

■ **Cautions**

Terminal Connection

When soldering the lead wire to the terminal, first insert the lead wire conductor through the terminal hole and then conduct soldering.

Make sure that the capacity of the soldering iron is 30 W maximum (temperature of soldering iron: 350°C max.). Do not take more than 3 s to solder the switch terminal.

If soldering is not carried out under the proper conditions there is a danger of over-heating and subsequent heat damage.

Applying a soldering iron for more than 3 s or using one that is rated at more than 30 W may deteriorate the Switch characteristics.

When soldering the lead wire to the PCB terminal, pay careful attention so that the flux and solder liquid level does not exceed the PCB level.

■ **Correct Use**

Mounting

Turn OFF the power supply before mounting or removing the Switch, wiring, or performing maintenance or inspection. Failure to do so may result in electric shock or burning.

Use M2 mounting screws with plane washers or spring washers to securely mount the Switch. Tighten the screws to a torque of 0.08 to 0.1 N•m {0.8 to 1 kgf•cm}.

Mount the Switch onto a flat surface. Mounting on an uneven surface may cause deformation of the Switch, resulting in faulty operation or breakage in the housing.

Operating Stroke Setting

Take particular care in setting the operating stroke for the pin plunger models. Make sure that the operating stroke is 70% to 100% of the rated OT distance. Do not operate the actuator exceeding the OT distance, otherwise the life expectancy of the Switch may be shortened.

Using Micro Loads

Using a model for ordinary loads to open or close the contact of a micro load circuit may result in faulty contact. Use models that operate in the following range. However, even when using micro load models within the operating range shown below, if inrush current occurs when the contact is opened or closed, it may increase contact wear and so decrease life expectancy. Therefore, insert a contact protection circuit where necessary.

The minimum applicable load is the N-level reference value. This value indicates the malfunction reference level for the reliability level of 60% ($\lambda 60$). The equation, $\lambda 60 = 0.5 \times 10^{-6}/\text{operations}$ indicates that the estimated malfunction rate is less than 1/2,000,000 operations with a reliability level of 60%.

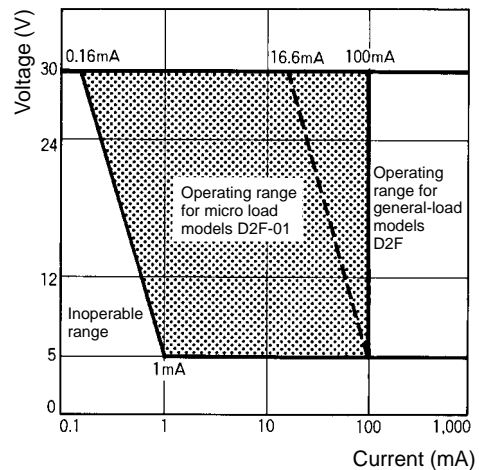

ALL DIMENSIONS SHOWN ARE IN MILLIMETERS.
To convert millimeters into inches, multiply by 0.03937. To convert grams into ounces, multiply by 0.03527.

Cat. No. B036-E1-07B

Tel:0755-83003780 Fax:0755-83003794 www.andiantech.com