

■ 特性

- 積層式警示燈可裝設於各種機械,以燈光及警鳴聲警示各種突發狀況,可依客戶不同的需求訂製適用的型式及規格。
- 內含彈簧緩衝及抗震設計,可大幅降低燈泡因機台劇烈的震動而損壞的機率。
- 接線自由性高,燈泡的閃滅或常亮及蜂鳴器的鳴聲為間歇或長鳴皆可自由配線改變。
- 鎢絲燈泡及LED燈泡燈座同為BA15S可自由互換。
- 含蜂鳴器的機種,其蜂鳴器音量約為90DB/30cm。
- 固定方式有盤式及桿式,並且有多種腳座可提供選擇。

■ 型號說明

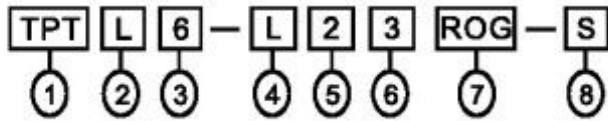

■ 燈泡型號說明

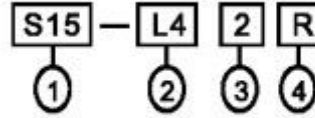

項次	代號	說明
1.固定方式	TPT	桿式
	TPW	盤式
	TPF	可折式(圓形鐵盤)
	TPFQ	可折式(方形鐵盤)
	TPA	側掛式
	TPS	桿盤式
2.功能	L	標準型
	F	閃光型
	S	閃光蜂鳴型
	B	蜂鳴型
3.外徑大小	4	φ40mm (無TPF.TPFQ)
	5	φ50mm
	6	φ60mm
	7	φ70mm
4.燈泡種類	空白	鎢絲燈泡
	L	LED
5.使用電壓	1	110VAC
	2	220VAC
	7	24VAC/DC
	9	12VAC/DC
6.燈數	1~5	1~5
7.燈殼顏色	R	紅
	O	橙
	G	綠
	B	藍
8.鋁管長(外露)	空白	標準長, TPT:288mm, TPF:43mm
	S	特殊長, TPT:138mm 特殊長, TPF:193mm

項次	代號	說明
1.燈座型式	S15	BA15S燈泡
2.適用燈殼外徑	I4	φ40mm用, 5W鎢絲燈泡
	I5	φ50mm用, 10W鎢絲燈泡
	I6	φ60mm/φ70mm用, 10W鎢絲燈泡
	L4	φ40mm用, LED燈泡
	L5	φ50mm/φ60mm/φ70mm用, LED燈泡
3.電壓	1	110VAC
	2	220VAC
	7	24VAC/DC
	9	12VAC/DC
4.燈泡顏色	空白	鎢絲燈泡
	R O G B W	紅 橙 綠 藍 白 LED燈泡

■ 燈泡外觀尺寸

鎢絲燈泡
S15-I□□

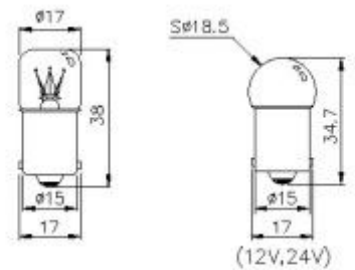

LED燈泡
S15-L4□□

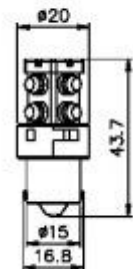

LED燈泡
S15-L5□□

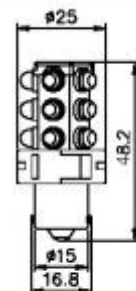

■ 燈泡及蜂鳴器額定電流(僅供參考)

鎢絲燈泡		LED燈泡	
S15-I49(12VAC/DC)	0.5A	S15-L49(12VAC/DC)	0.1A
S15-I47(24VAC/DC)	0.25A	S15-L47(24VAC/DC)	0.03A
S15-I41(110VAC)	0.05A	S15-L41(110VAC)	0.02A
S15-I42(220VAC)	0.03A	S15-L42(220VAC)	0.02A
S15-I59(12VAC/DC)	0.7A	S15-L59(12VAC/DC)	0.15A
S15-I57(24VAC/DC)	0.35A	S15-L57(24VAC/DC)	0.04A
S15-I51(110VAC)	0.06A	S15-L51(110VAC)	0.02A
S15-I52(220VAC)	0.03A	S15-L52(220VAC)	0.02A
S15-I69(12VAC/DC)	0.8A	蜂鳴器	
S15-I67(24VAC/DC)	0.4A		
S15-I61(110VAC)	0.08A		
S15-I62(220VAC)	0.04A		
		12VAC/DC	0.08A
		24VAC/DC	0.02A
		110VAC	0.01A
		220VAC	0.01A

■ 固定孔尺寸

● 盤式

TPW □4/TPW □5

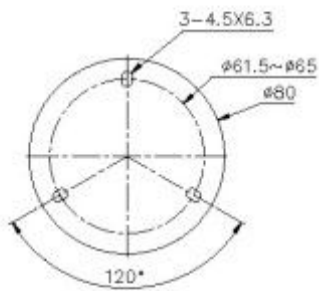

TPW □6

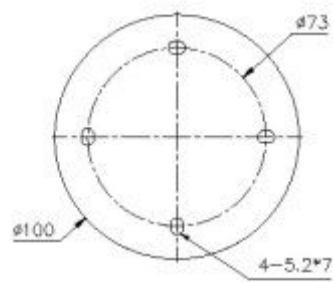

TPW □7

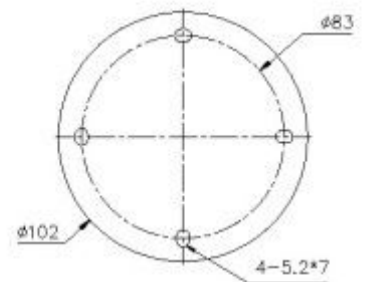

■ 固定孔尺寸

● 桿式腳架

使用於TPTL4

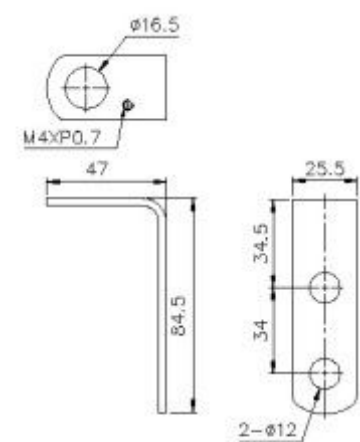

使用於TPT □6/TPT □7

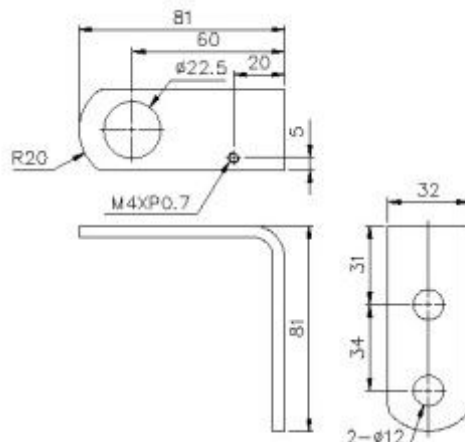

使用於TPTF4/TPTS4/TPTB4
TPT □5

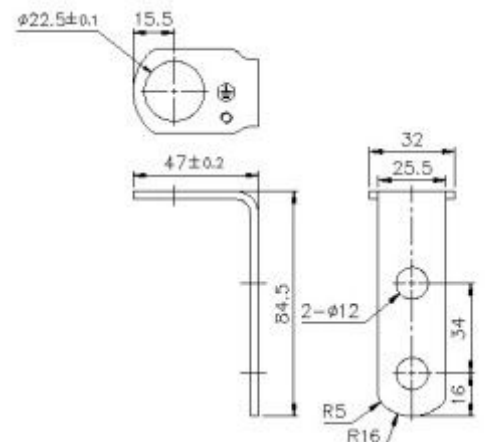

■ 固定孔尺寸

● 桿式腳座(選購件)

TPTL-S
使用於TPSL4

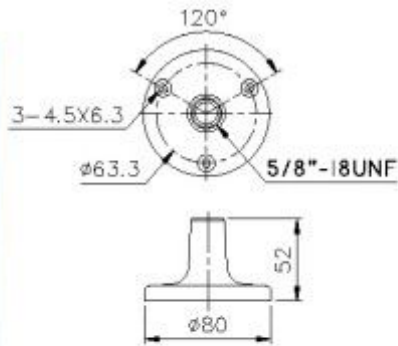

TPTL6-S
使用於TPSS4/TPSF4/TPSB4
TPS□5/TPS□6/TPS□7

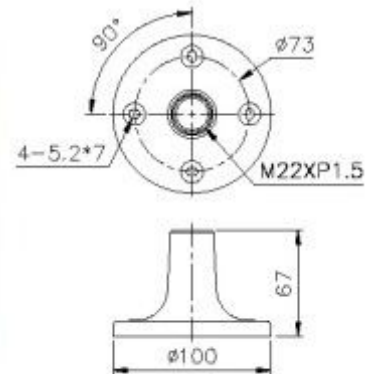

■ 固定孔尺寸

● 側式腳座(選購件)

TPTL6-A
使用於TPA□4
TPA□5/TPA□6/TPA□7

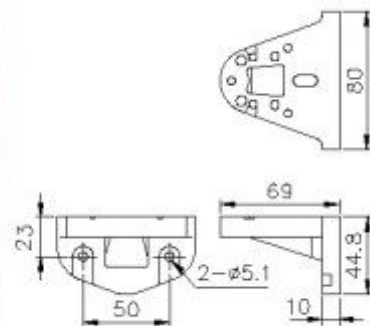

● 可折式腳座(選購件)

TPTL6-F (新型式專利, 圓形塑膠盤)
使用於TPFS4/TPFF4/TPFB4
TPF□5/TPF□6/TPF□7

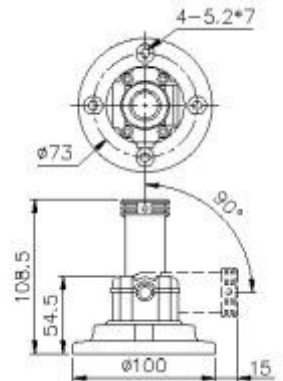

TPTL5-F (新型式專利)
使用於TPFS4/TPFF4/TPFB4
TPF□5/TPF□6/TPF□7

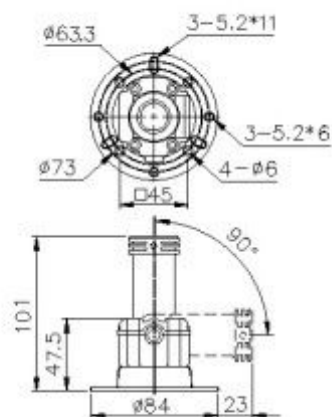

TPTL5-FS (新型式專利)
使用於TPFS4/TPFF4/TPFB4
TPF□5/TPF□6/TPF□7

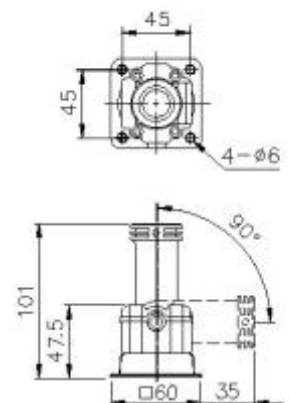



■外觀和尺寸

TPTL4

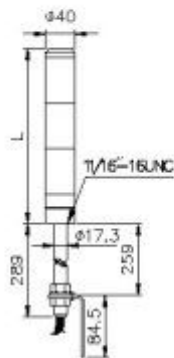

● TPTL4:

燈數	L
1	114
2	176
3	238
4	300
5	362

TPTF4/TPTS4/TPTB4

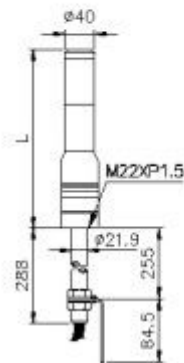

● TPTF4/TPTS4
TPTB4:

燈數	L
1	177
2	239
3	301
4	363
5	425

TPWL4

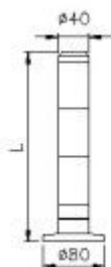

● TPWL4:

燈數	L
1	122
2	184
3	246
4	308
5	370

TPWF4/TPWS4/TPWB4

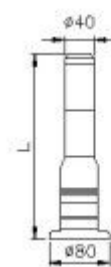

● TPWF4/TPWS4
TPWB4:

燈數	L
1	183
2	245
3	307
4	369
5	431

■外觀和尺寸

TPSL4

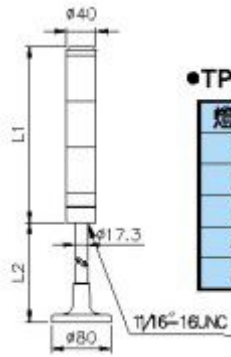

●TPSL4:

燈數	L1	L2
1	114	短133
2	176	長298
3	238	
4	300	
5	362	

TPSF4/TPSS4/TPSB4

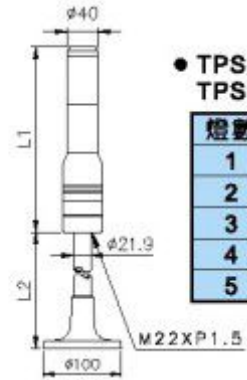

●TPSF4/TPSS4
TPSB4:

燈數	L1	L2
1	177	短161
2	239	長322
3	301	
4	363	
5	425	

TPFF4/TPFS4/TPFB4

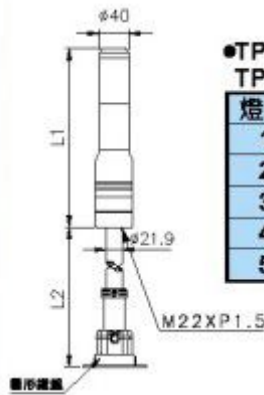

●TPFF4/TPFS4
TPFB4:

燈數	L1	L2
1	177	短146
2	239	長296
3	301	
4	363	
5	425	

TPFQF4/TPFQS4/TPFQB4

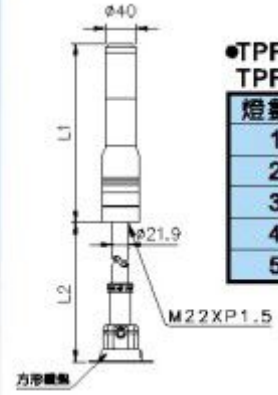

●TPFQF4/TPFQS4
TPFQB4:

燈數	L1	L2
1	177	短146
2	239	長296
3	301	
4	363	
5	425	

TPAL4

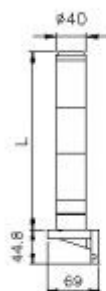

●TPAL4:

燈數	L
1	114
2	176
3	238
4	300
5	362

TPAF4/TPAS4/TPAB4

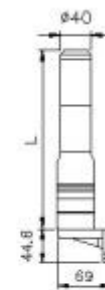

●TPAF4/TPAS4
TPAB4:

燈數	L
1	177
2	239
3	301
4	363
5	425

■外觀和尺寸

TPTL5

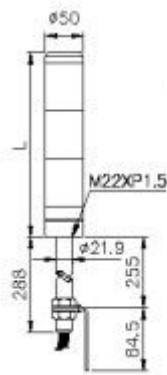

● TPTL5:

燈數	L
1	118
2	182
3	246
4	310
5	374

TPTF5/TPTS5/TPTB5



● TPTF5/TPTS5
TPTB5:

燈數	L
1	182
2	246
3	310
4	374
5	438

TPWL5

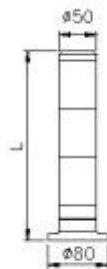

● TPWL5:

燈數	L
1	124
2	188
3	252
4	316
5	380

TPWF5/TPWS5/TPWB5



● TPWF5/TPWS5
TPWB5:

燈數	L
1	188
2	252
3	316
4	380
5	444

TPSL5

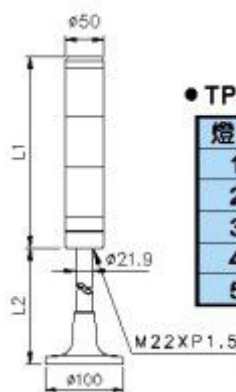

● TPSL5:

燈數	L1	L2
1	118	短161
2	182	長322
3	246	
4	310	
5	374	

TPSF5/TPSS5/TPSB5

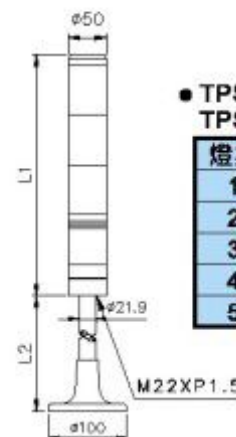

● TPSF5/TPSS5
TPSB5:

燈數	L1	L2
1	182	短161
2	246	長322
3	310	
4	374	
5	438	

■外觀和尺寸

TPFL5

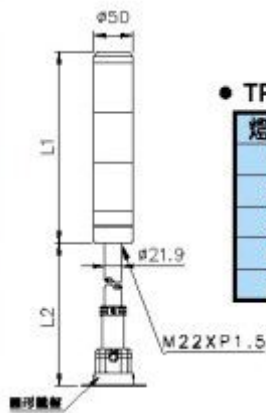

● TPFL5:

燈數	L1	L2
1	118	短146
2	182	長296
3	246	
4	310	
5	374	

TPFQL5

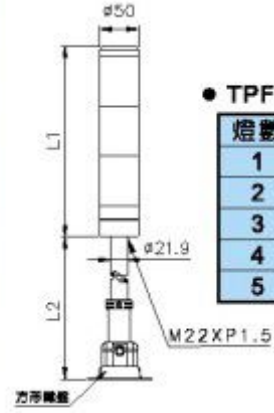

● TPFQL5:

燈數	L1	L2
1	118	短146
2	182	長296
3	246	
4	310	
5	374	

TPFF5/TPFS5/TPFB5

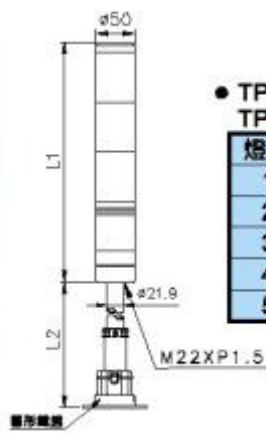

● TPFF5/TPFS5
TPFB5:

燈數	L1	L2
1	182	短146
2	246	長296
3	310	
4	374	
5	438	

TPFQF5/TPFQS5/TPFQB5

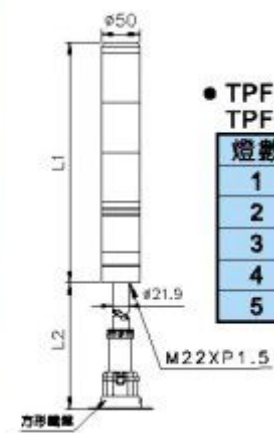

● TPFQF5/TPFQS5
TPFQB5:

燈數	L1	L2
1	182	短146
2	246	長296
3	310	
4	374	
5	438	

TPAL5

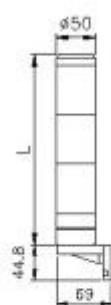

● TPAL5:

燈數	L
1	118
2	182
3	246
4	310
5	374

TPAF5/TPAS5/TPAB5

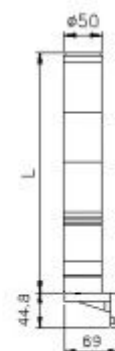

● TPAF5/TPAS5
TPAB5:

燈數	L
1	182
2	246
3	310
4	374
5	438

■外觀和尺寸

TPTL6

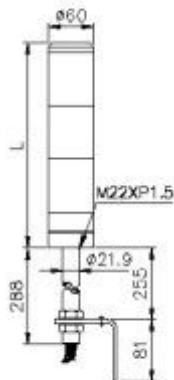

● TPTL6:

燈數	L
1	130
2	200
3	270
4	340
5	410

TPTF6/TPTS6/TPTB6

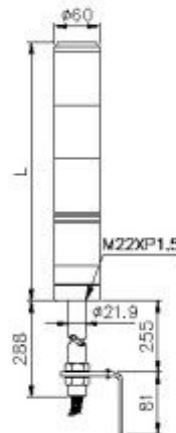

● TPTF6/TPTS6
TPTB6:

燈數	L
1	200
2	270
3	340
4	410
5	480

TPWL6

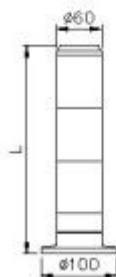

● TPWL6:

燈數	L
1	136
2	206
3	276
4	346
5	416

TPWF6/TPWS6/TPWB6

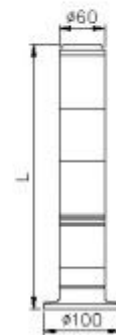

● TPWF6/TPWS6
TPWB6:

燈數	L
1	206
2	276
3	346
4	416
5	486

TPSL6

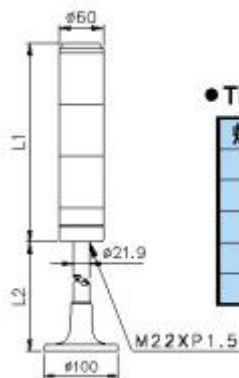

● TPSL6:

燈數	L1	L2
1	130	短161
2	200	長322
3	270	
4	340	
5	410	

TPSF6/TPSS6/TPSB6

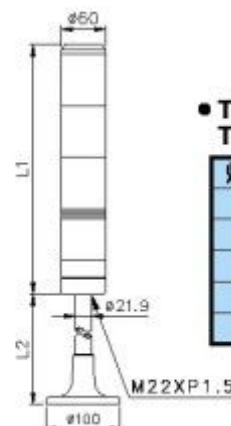

● TPSF6/TPSS6
TPSB6:

燈數	L1	L2
1	200	短161
2	270	長322
3	340	
4	410	
5	480	

■ 外觀和尺寸

TPFL6

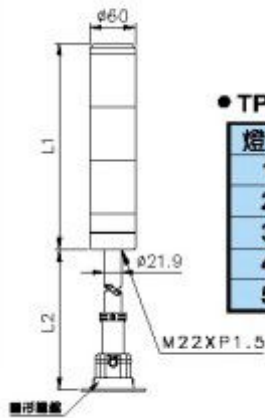

● TPFL6:

燈數	L1	L2
1	130	短146
2	200	長296
3	270	
4	340	
5	410	

TPFQL6

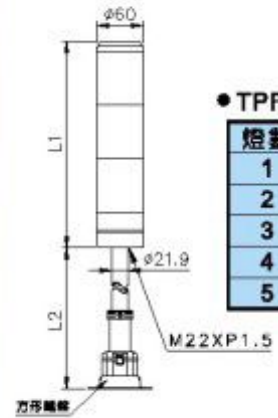

● TPFQL6:

燈數	L1	L2
1	130	短146
2	200	長296
3	270	
4	340	
5	410	

TPFF6/TPFS6/TPFB6

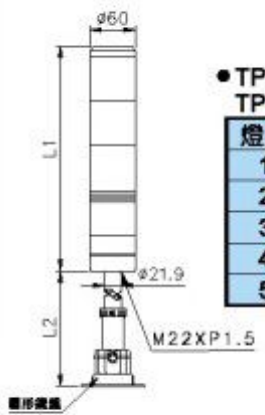

● TPFF6/TPFS6
TPFB6:

燈數	L1	L2
1	200	短146
2	270	長296
3	340	
4	410	
5	480	

TPFQF6/TPFQS6/TPFQB6

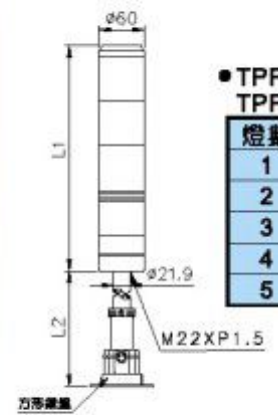

● TPFQF6/TPFQS6
TPFQB6:

燈數	L1	L2
1	200	短146
2	270	長296
3	340	
4	410	
5	480	

TPAL6

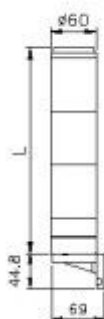

● TPAL6:

燈數	L
1	130
2	200
3	270
4	340
5	410

TPAF6/TPAS6/TPAB6



● TPAF6/TPAS6
TPAB6:

燈數	L
1	200
2	270
3	340
4	410
5	480

外觀和尺寸

TPTL7

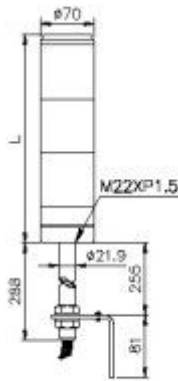

● TPTL7:

燈數	L
1	130
2	200
3	270
4	340
5	410

TPTF7/TPTS7/TPTB7

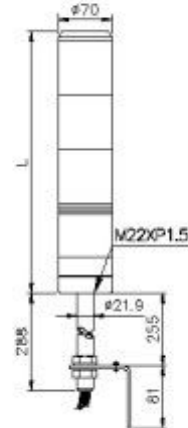

● TPTF7/TPTS7
TPTB7:

燈數	L
1	200
2	270
3	340
4	410
5	480

TPWL7

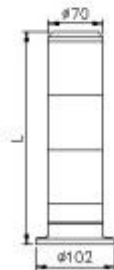

● TPWL7:

燈數	L
1	136
2	206
3	276
4	346
5	416

TPWF7/TPWS7/TPWB7

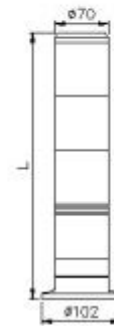

● TPWF7/TPWS7
TPWB7:

燈數	L
1	206
2	276
3	346
4	416
5	486

TPSL7

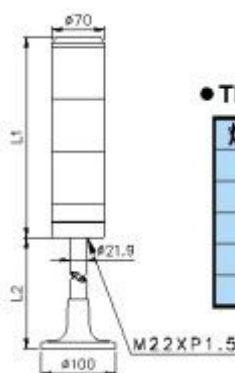

● TPSL7:

燈數	L1	L2
1	130	短161
2	200	長322
3	270	
4	340	
5	410	

TPSF7/TPSS7/TPSB

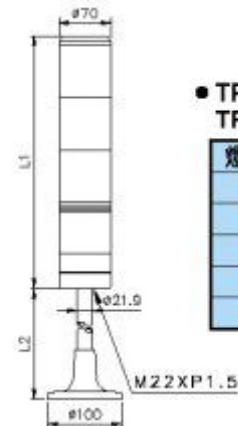

● TPSF7/TPSS7
TPSB7:

燈數	L1	L2
1	200	短161
2	270	長322
3	340	
4	410	
5	480	

■外觀和尺寸

TPFL7

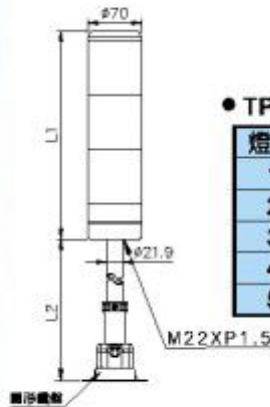

● TPFL7:

燈數	L1	L2
1	130	短146
2	200	長296
3	270	
4	340	
5	410	

TPFQL7

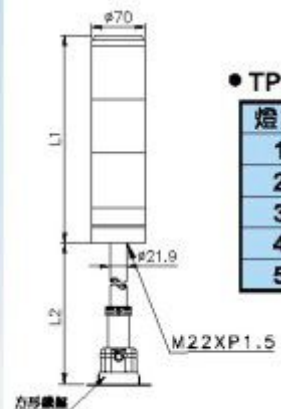

● TPFQL7:

燈數	L1	L2
1	130	短146
2	200	長296
3	270	
4	340	
5	410	

TPFF7/TPFS7/TPFB7

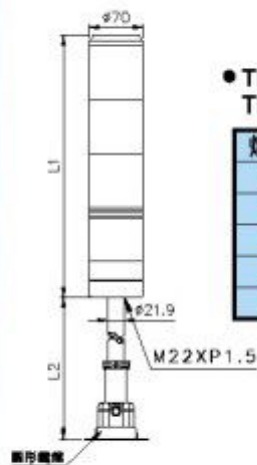

● TPFF7/TPFS7
TPFB7:

燈數	L1	L2
1	200	短146
2	270	長296
3	340	
4	410	
5	480	

TPFQF7/TPFQS7/TPFQB7

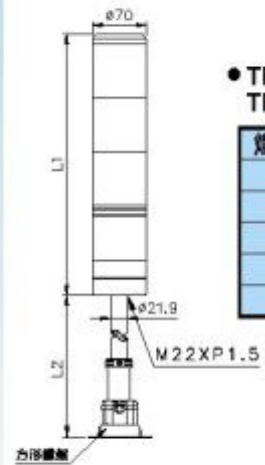

● TPFQF7/TPFQS7
TPFQB7:

燈數	L1	L2
1	200	短146
2	270	長296
3	340	
4	410	
5	480	

TPAL7

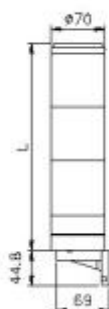

● TPAL7:

燈數	L
1	130
2	200
3	270
4	340
5	410

TPAF7/TPAS7/TPAB7

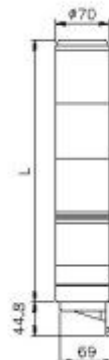

● TPAF7/TPAS7
TPAB7:

燈數	L
1	200
2	270
3	340
4	410
5	480

特性

- 天得積層式警示燈可裝設於各種機械,以燈光及警鳴聲警示各種突發狀況,可依客戶不同的需求訂製適用的型式及規格。
- 接線自由性高,燈泡的閃滅或常亮及蜂鳴器的鳴聲為間歇或長鳴皆可自由配線改變。
- 含蜂鳴器的機種,其蜂鳴器音量約為90DB/30cm。

型號說明

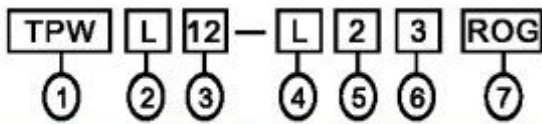

項次	代號	說明
1.固定方式	TPW	圓型直附式
2.功能	L	標準型
	F	閃光型
	S	閃光蜂鳴型
	B	蜂鳴型
3.外徑大小	12	Ø120mm
4.燈泡總類	L	LED
5.使用電壓	1	110VAC
	2	220VAC
	7	24VAC/DC
	9	12VAC/DC
6.燈數	1-5	1-5
7.燈殼顏色	R	紅
	O	橙
	G	綠
	B	藍
	W	白

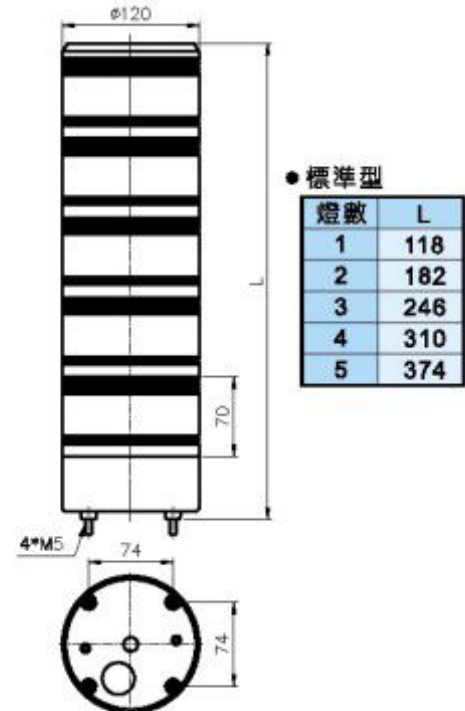

接線圖 (DC電壓, 電源線上標示正負極)

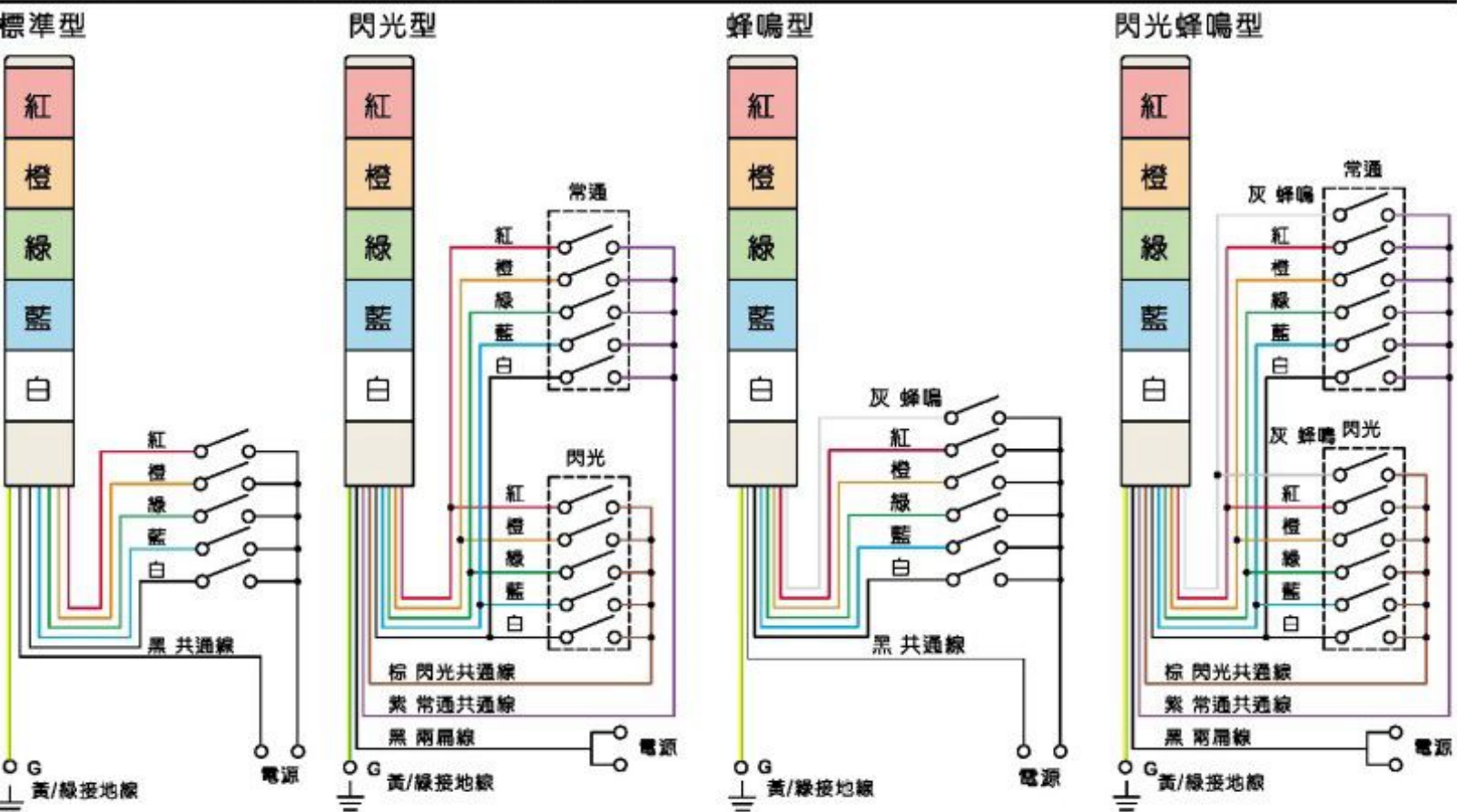

■ 特性

- 積層式警示燈可裝設於各種機械,以燈光及警鳴聲警示各種突發狀況,可依客戶不同的需求訂製適用的型式及規格。
- 內含彈簧緩衝及抗震設計,可大幅降低燈泡因機台劇烈的震動而損壞的機率。
- 接線自由性高,燈泡的閃滅或常亮及蜂鳴器的鳴聲為間歇或長鳴皆可自由配線改變。
- 鎢絲燈泡及LED燈泡燈座同為BA15S可自由互換。
- 含蜂鳴器的機種,其蜂鳴器音量約為90DB/30cm。
- 接線圖請見(H17)頁。

■ 型號說明

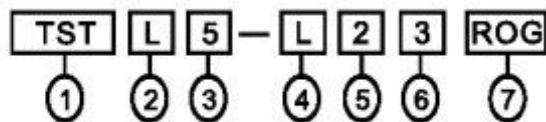

項次	代號	說明
1.固定方式	TST	方型桿式
	TSW	方型直附式
	TSF	方型可折式(圓形鐵盤)
	TSFQ	方型可折式(方形鐵盤)
	TSS	桿盤式
2.功能	L	標準型
	F	閃光型
	S	閃光蜂鳴型
	B	蜂鳴型
3.外徑大小	5	50mmx50mm

項次	代號	說明
4.燈泡總類	空白	鎢絲燈泡
	L	LED
5.使用電壓	1	110VAC
	2	220VAC
	7	24VAC/DC
	9	12VAC/DC
6.燈數	1~5	1~5
7.燈殼顏色	R	紅
	O	橙
	G	綠
	B	藍
8.鋁管長(外總)	空白	標準長, TST:288mm, TSF:43mm
	S	特殊長, TST:138mm 特殊長, TSF:193mm

■ 外觀和尺寸

TSTL

● 標準型	
燈數	L
1	118
2	182
3	246
4	310
5	374

TSTF/TSTS/TSTB

● 閃光型、蜂鳴型 閃光蜂鳴型	
燈數	L
1	182
2	246
3	310
4	374
5	438

TSSL

● 標準型		
燈數	L1	L2
1	118	短161 長322
2	182	
3	246	
4	310	
5	374	

TSSF/TSSS/TSSB

● 閃光型、蜂鳴型 閃光蜂鳴型		
燈數	L1	L2
1	182	短161 長322
2	246	
3	310	
4	374	
5	438	

■外觀和尺寸

TSFL

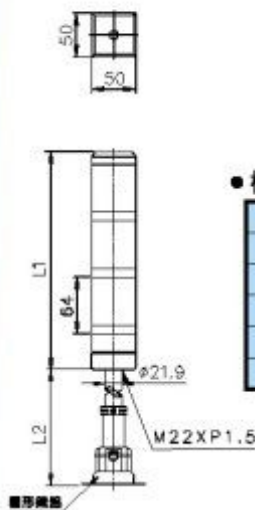

●標準型

燈數	L1	L2
1	118	短146
2	182	長296
3	246	
4	310	
5	374	

TSFQL

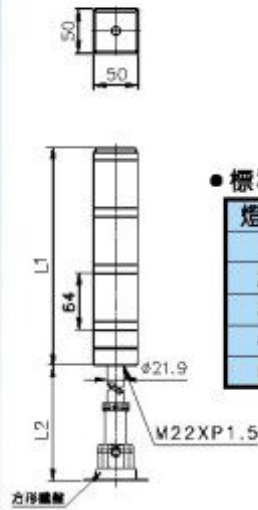

●標準型

燈數	L1	L2
1	118	短146
2	182	長296
3	246	
4	310	
5	374	

TSFF/TSFS/TSFB

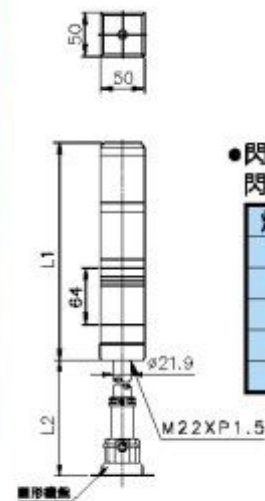

●閃光型·蜂鳴型
閃光蜂鳴型

燈數	L1	L2
1	182	短146
2	246	長296
3	310	
4	374	
5	438	

TSFQF/TSFQS/TSFQB

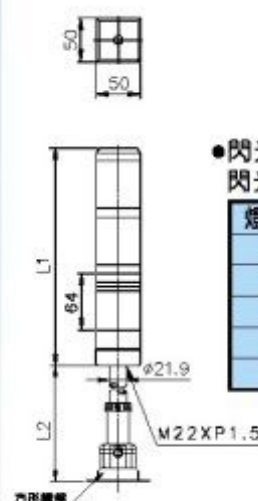

●閃光型·蜂鳴型
閃光蜂鳴型

燈數	L1	L2
1	182	短146
2	246	長296
3	310	
4	374	
5	438	

TSWL

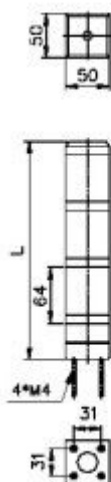
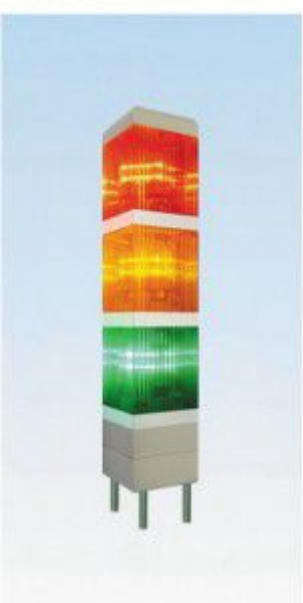

●標準型

燈數	L
1	118
2	182
3	246
4	310
5	374

TSWF/TSWS/TSWB

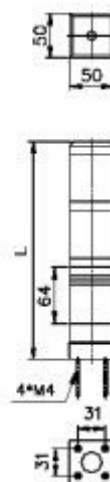

●閃光型·蜂鳴型
閃光蜂鳴型

燈數	L
1	182
2	246
3	310
4	374
5	438

特性

- 此系列警示燈主要特點為單層多色, 可降低總高度, 有紅, 橙, 綠, 藍四種顏色, 以供選擇。
- 旋轉轉速為180轉/分, 閃光頻率為60次/分。
- 蜂鳴聲為間歇式時, 串接旋轉線時, 頻率為180次/分, 串接閃光線時, 頻率為60次/分, 音量為80db/1m以上。

型號說明

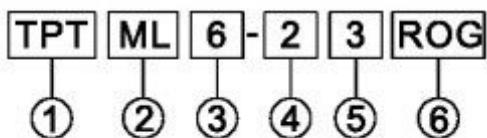

項次	代號	說明
1. 固定方式	TPT	桿式
	TPW	盤式
	TPF	可折式(圓形鐵盤)
	TPFQ	可折式(方形鐵盤)
	TPA	側掛式
	TPS	桿盤式
	2. 功能	ML
MF		常亮, 閃光
MB		常亮, 蜂鳴
MS		常亮, 閃光, 蜂鳴
RF		旋轉, 常亮, 閃光
RS		旋轉, 常亮, 閃光, 蜂鳴

項次	代號	說明
3. 燈殼外徑	5	Ø50mm (研發中)
	6	Ø60mm
4. 使用電壓	1	110VAC
	2	220VAC
	7	24VAC/DC
	9	12VAC/DC
5. 燈色數目	2~4	2~4
6. 燈顏色	R	紅
	O	橙
	G	綠
	B	藍

外觀和尺寸

TPTM/TPTR

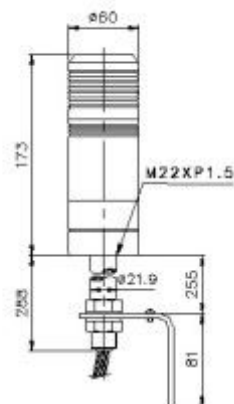

TPWM/TPWR

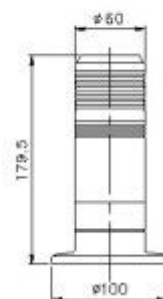

TPSM/TPSR



TPFM/TPFR

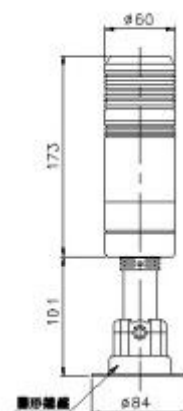

外觀和尺寸

TPFQM/TPFQR

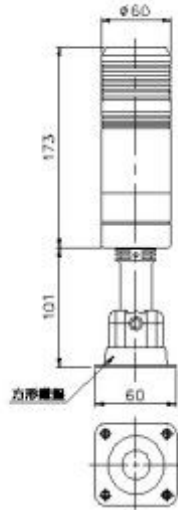

TPAM/TPAR

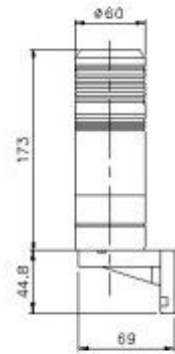

接線圖 (DC電壓, 電源線上標示正負極)

標準型(ML)

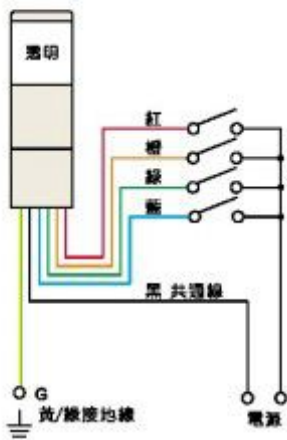

閃光型(MF)

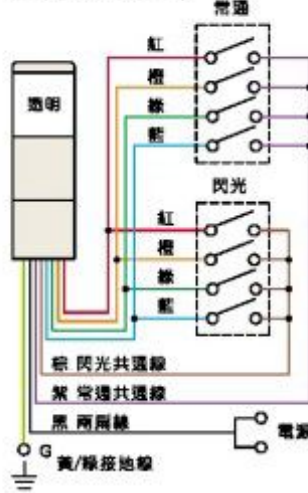

蜂鳴型(MB)

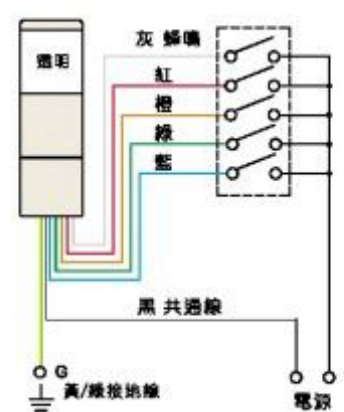

閃光蜂鳴型(MS)

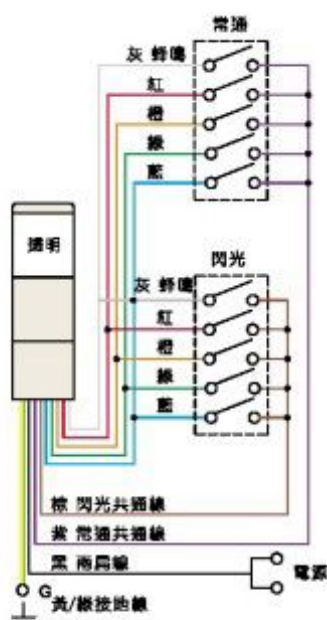

旋轉閃光型(RF)

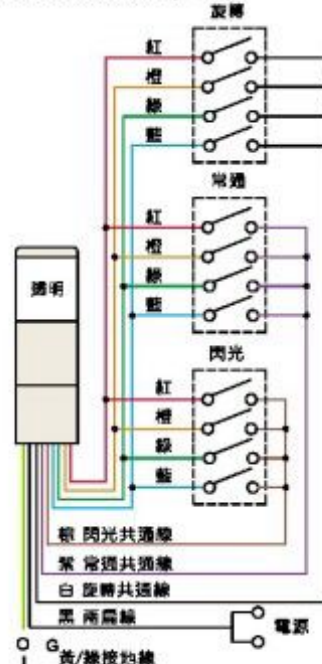

旋轉閃光
蜂鳴型(RS)

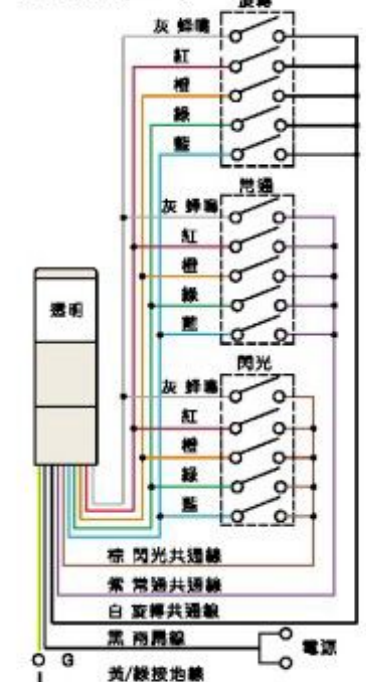

註:紅,橙,綠,藍的白燈線與蜂鳴線(灰),只限接其中一條功能線