



Bluetooth V5.0 BLE RS-485 Serial Adapter

Model: S2B5485I

1. Package content:

<p>BLE V5.0 RS-485 adapter</p>  <p>White Box: 11 x 6 x 5 (cm) Total Package Weight: 100 g</p> 	<p>Package Contents:</p> <ul style="list-style-type: none"> ● BLE V5.0 RS-485 adapter x 1 ● A4 User manual x 1 ● Mini USB Cable x 1 
--	---

2. Profile:

2.1 Top view:



LED:
Link: Blue
PWR/Data: Red

DB9 (Male)

Reset to Default

Mini USB (Power)

▲ + (5~40 VDC)
▼ GND

Antenna Inside
(Keep clear area)

LED Status	Description
Data LED flash	Data transmission
Data LED solid on	No data transmission
Link LED solid on	BLE Link
Link LED flash	No Link
Data & Link LED solid on	DFU/OTA Mode

2.2 Rear Side:

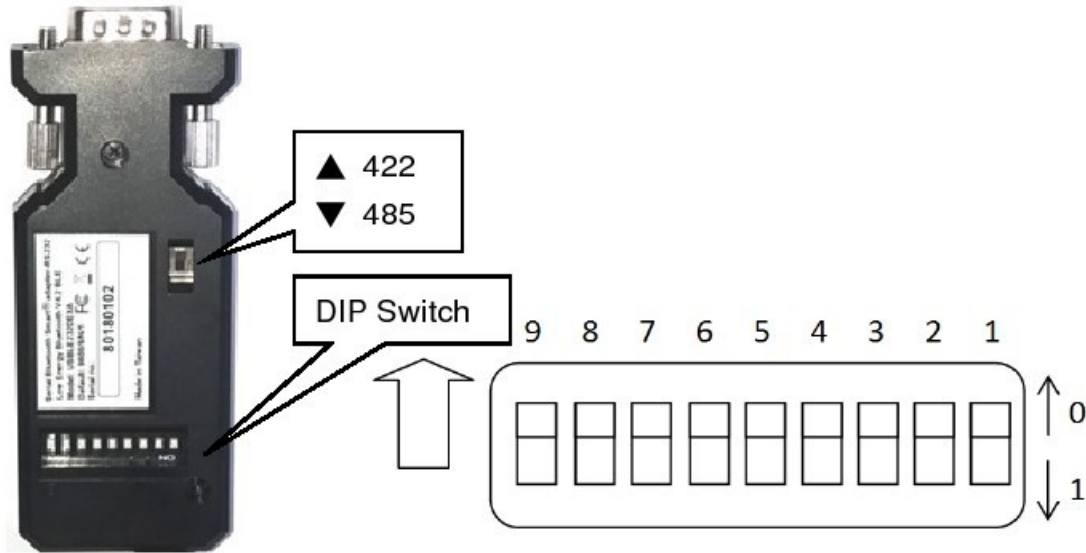

Switch configuration:

Setup	CRC	UNUSED	Parity	Role	Baud Rate
9	8	7 - 6	5	4	3-2-1
0: AT commands or app. 1: DIP Switches	0: Disable 1: Enable		0: None 1: Even	0: Peripheral 1: Central (Auto link with peripheral)	110:2400 111:4800 000:9600 001:19200 010:38400 011:57600 100:115200 101:230400

Remark:

1. 000000000 by default, in **red bold** character
2. The GATT service and AT command will support more settings than the DIP switch, please check the page 4 section 5 and page 5 section 6.

2.3 DB9 Pin definition

No.	Function	Remark
1	A (RX+)	D+, A=Y (RS-485)
2	B (RX-)	D-, B=Z (RS-485)
3	Y (TX+)	
4	Z (TX-)	
5	GND	
6	Vin-1	5-40VDC, Vin-1 or Vin-2 choose one
7	N/A	
8	N/A	
9	Vin-2	5-40VDC, Vin-1 or Vin-2 choose one

2.4 DB9 to 6P block terminal connector: (Option)



Please follow the pin definition to connect the external device.



3. Power supply:

3.1 Voltage: 5~40 VDC, **Don't exceed the limit.**

3.2 There're 3 ways to power the adapter: Mini USB, 2P Terminal Block (Blue) and pin9 of DB9, please choose one. **Don't power the adapter by more than one source.**

3.3 The mini USB to type A cable is inside the standard package.

4. Specifications:

4.1 Default value:

- Baud rate: 9,600 bps
- Data bit: 8
- Parity: none
- Stop bit: 1
- Flow control: none
- Device Name: BLE 485
- Pin code: None

4.2 Serial Port:

- Baud Rate: 1.2/2.4/4.8/9.6/19.2/38.4/57.6/115.2/230.4 Kbps
- Parity: none/even, w/o Odd
- Stop bit: 1 only
- Data bit: 8 only

Remark: The GATT service and AT command will support all the functions, please check the page 4 section 5 and page 5 section 6.

4.3 Range: max. 50 m in open space (The range depends on the real environment.)

4.4 TX Power: Max. 4 dBm

4.5 RX Sensitivity: -96 dBm typical

4.6 TX current consumption of 16.6 mA (radio only, 4 dbm)

4.7 Operation Temperature: -40 °C to +85 °C

4.8 Dimensions: 87 mm (L) x 34 mm (W) x 18 mm (H)

4.9 Antenna Gain: max. 2 dB (Default)

Remark: All contents are subject to change without notice.

5. GATT Service:

5.1 Architecture:

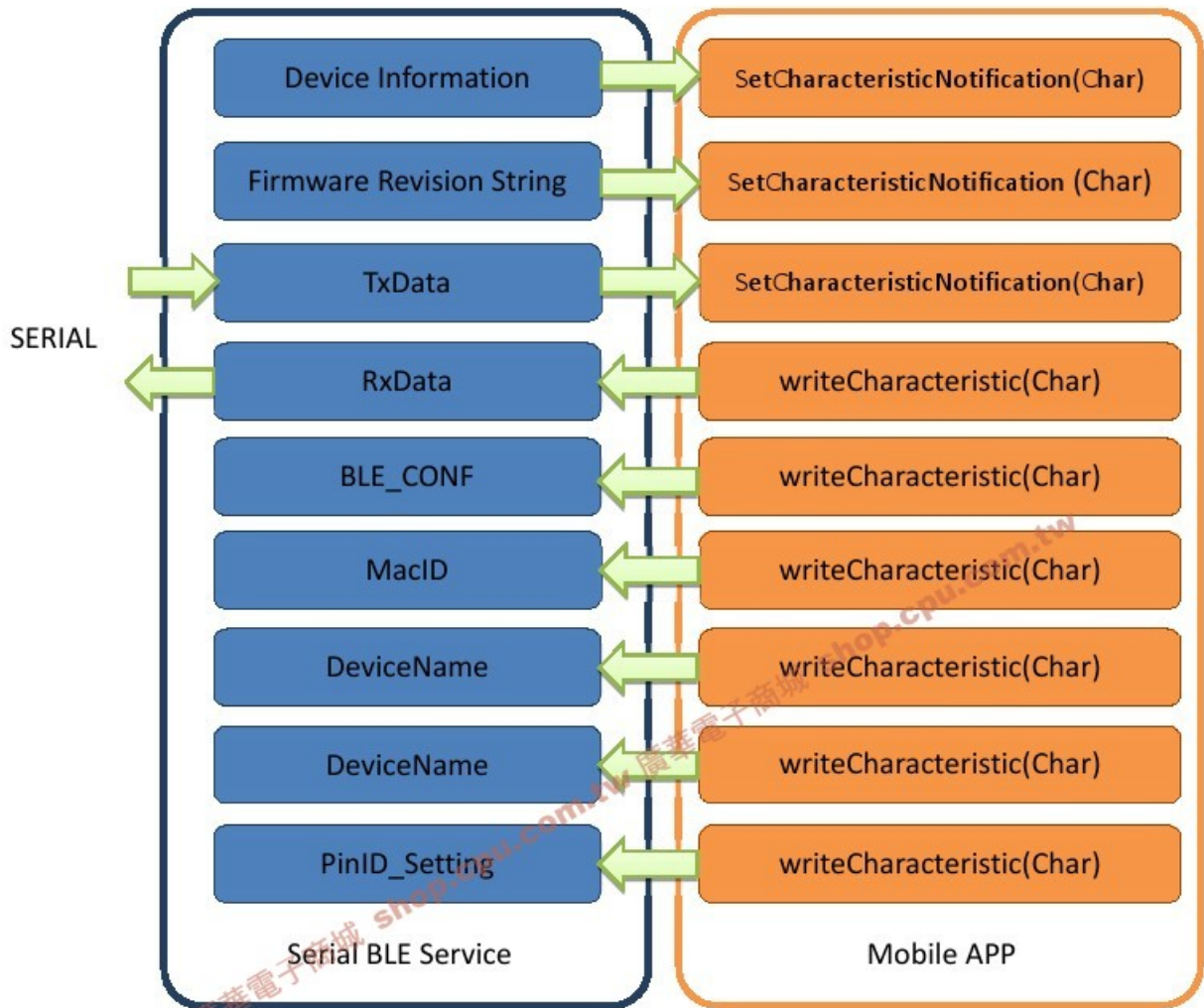

5.2 Service UUID: 0003ABCD-0000-1000-8000-00805F9B0131

GATT	UUID		
UUID_Device Information	0000180A-0000-1000-8000-00805F9B0131		
UUID_Firmware Revision String	00002A26-0000-1000-8000-00805F9B0131		
UUID_RxData (~251 bytes, depends on OS)	00031201-0000-1000-8000-00805F9B0130		
UUID_TxData (~251 bytes, depends on OS)	00031202-0000-1000-8000-00805F9B0130		
UUID_MacID (6 bytes)	00031204-0000-1000-8000-00805F9B0130		
UUID_DeviceName (15 bytes)	00031205-0000-1000-8000-00805F9B0130		
UUID_PinID_Setting (6 bytes)	00031206-0000-1000-8000-00805F9B0130		
UUID_Reboot (2 bytes)	00031210-0000-1000-8000-00805F9B0130		
UUID_BLE_Config (4 bytes) 00031203-0000-1000-8000-00805F9B0130:			
Byte0 (Read Only)	Byte1	Byte2	Byte3
Product model	Baud Rate	N/A	Port setting
0xAA: RS232	0x00: 1200 bps		bit 0: Parity (0: NONE 1: EVEN)
0xAF: RS485/422	0x01: 2400 bps		bit 1: Flow control (0: Disabled 1: Enabled) (for RS232 model Only)

0x02: 4800 bps	bit 2: N/A
0x03: 9600 bps	bit 3: Port Type (0: RS485 1: RS422) (Available on RS485 model only)
0x04: 19200 bps	bit 4: BLE Role (0: Peripheral 1: Central) (indication Only)
0x05: 38400 bps	bit 5: ControlSet (0: set by APP or command 1: set by 9P switch) (indication Only)
0x06: 57600 bps	
0x07: 115200 bps	
0x08: 230400 bps	

6. Command set via COM port:

Command	Value	Description
AT		Check the connection status between control terminal and the RS-232 adapter. Response: "OK" when the connection is ok. Response: "ERROR" when the connection is not ok.
AT		Test the RS-232 status when first connect the adapter with the controller.
(Default)	N	The command will disable the auto link function.
	?	Inquire the current setting.
BAUD=		This command is used to specify the baud rate of COM port. The command will need 200 ms delay.
	1200	1200 bps
	2400	2400 bps
	4800	4800 bps
	9600	9600 bps
(Default)	19200	19200 bps
	38400	38400 bps
	57600	57600 bps
	115200	115200 bps
	230400	230400 bps
	?	Inquire the current baud rate.
DEFAULT=		This command is used to restore the default settings and originate a warm start.
	Y	Restore the default settings (e.g. 19200 bps). The command will re-start the system for 1 second.
DFU=		Device Firmware Upgrade via PC software. OTA (Over the air) is available to upgrade the firmware by APP
	Y	
ECHO=		This command is used to specify whether the adaptor echoes characters received from the UART back to the DTE/DCE.
	N	Command characters received from the UART are not echoed back to the DTE/DCE.
(Default)	Y	Command characters received from the UART are echoed back to the DTE/DCE.
	?	Inquire the current setting.
NAME=		This command is used to specify a device name for the adaptor. You can specify a friendly name using 0 to 9, A to Z, a to z, space and -, which are all valid characters. Note that "first space or -, last space or

		– isn't permitted". The default name is "Serial Adaptor".
(Default)	BLE485	Default device name
	xx....xx	"xx....xx" is a character string with the length from 2 to 30.
	R	Restore the default settings name="BLE Serial".
	?	Inquire the name of the local adaptor.
PARITY=		This command is used to specify parity bit setting of COM port. The command will need 200 ms delay.
(Default)	N	None parity bit
	E	Even parity
	?	Inquire the current setting.
PIN=		None Pin code. Simple fast pairing enabled.
	xx....xx	"xx....xx" is a 0~9 number
	?	Inquire the current PIN.
PROMPT=		The command is used to decide whether result messages are prompted when Setup commands are executed. The result messages are: OK/ERROR for command execution.
(Default)	Y	Prompt result messages.
	N	Not prompt result messages.
	?	Inquire the current setting.
ROLE=		This command is used to specify whether the adaptor is in the central or peripheral role. If the device role is changed, the adaptor will reboot and all paired addresses will be cleared.
	C	Set the adaptor to the central role.
(Default)	P	Set the adaptor to the peripheral role.
	?	Inquire the current role of the adaptor.
STATUS=		Inquire all the current setting of the adaptor.
	?	Display the current setting of the adapter
VERSION=		This command is used to inquiry the firmware version.
	?	Inquire the version codes.

7. Central and Peripheral: (Similar like the Master and Slave roles)

By DIP switches: The central will pair the slave automatically.

- Switch DIP-9 to 1 (Configuration by DIP Switch)
- Switch DIP-4 to 1 (Central)
- The central will link with the neighboring peripheral automatically. The blue LED will be solid on. The central will link with the paired peripheral next time when powered on.
- Please reset to default and follow above procedure if you want to link with other BLE devices.

By AT command:

- Set "role=c" or "ROLE=C" in one adapter.
- Set "auto=y" or "AUTO=Y" to enable the auto link
- The central will link with the neighboring peripheral automatically. The blue LED will be solid on. The central will link with the paired peripheral next time

when powered on.

- Please reset to default and follow above procedure if you want to link with other BLE devices.

By APP setup: (apps can be downloaded from Google Play or Apple Store):

- The APP will search the BLE and select one as the central.
- Then select the other one as the peripheral and link.
- The central will link with the neighboring peripheral automatically. The blue LED will be solid on. The central will link with the paired peripheral on next time when power on.
- Please reset to default and follow the above procedures if you want to link with other BLE devices.

The APP is used for configuring the parameters and can also be used for data transmission tests.

Android: The Android app can be downloaded from the Google Play Store:

<https://play.google.com/store/apps/details?id=tw.com.uconnect.ble232>

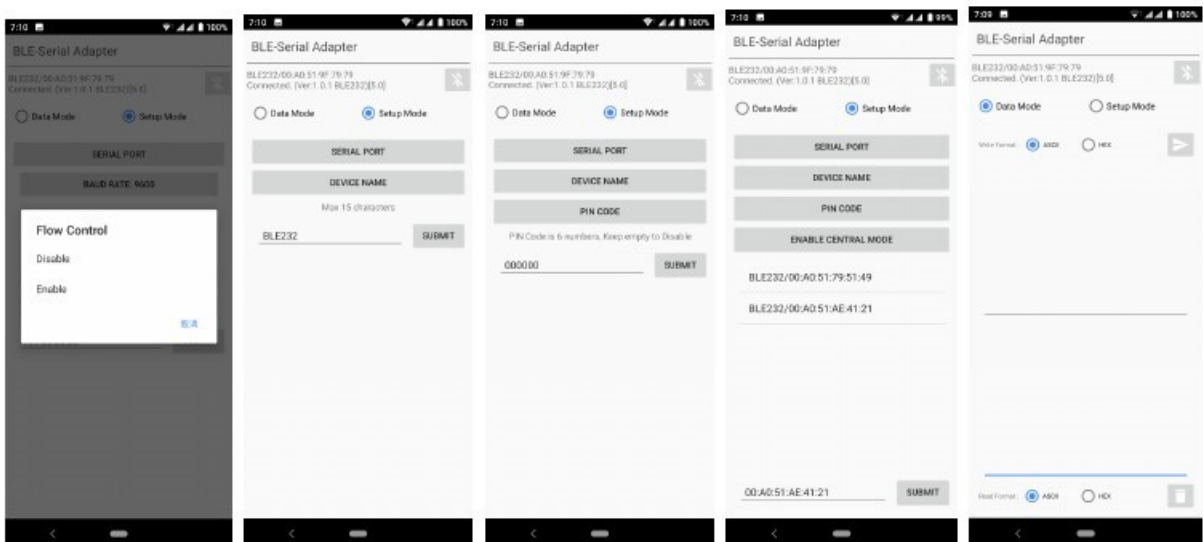
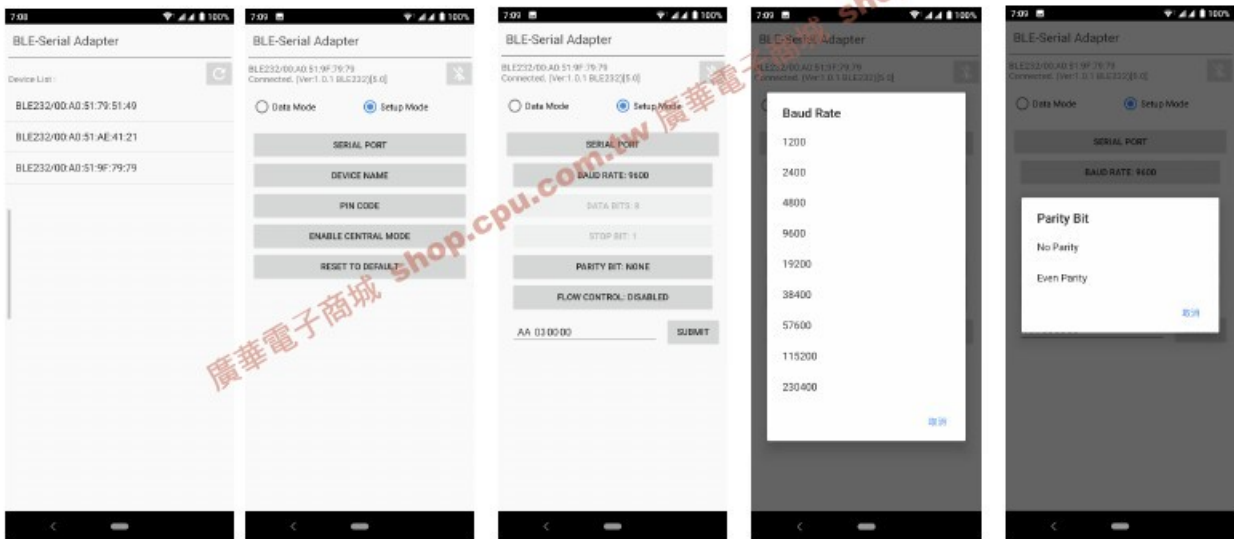

iOS: The same configuration procedures as Android version. The app for iOS can be downloaded from the Apple Play

Store: <https://itunes.apple.com/us/app/ble-to-serial-terminal/id1238004134?l=zh&ls=1&mt=8>

Download: Please contact the supplier for the APP download or the sample code.

Android:



iOS:



廣華電子商城 shop.cpu.com.tw 廣華電子商城 shop.cpu.com.tw